

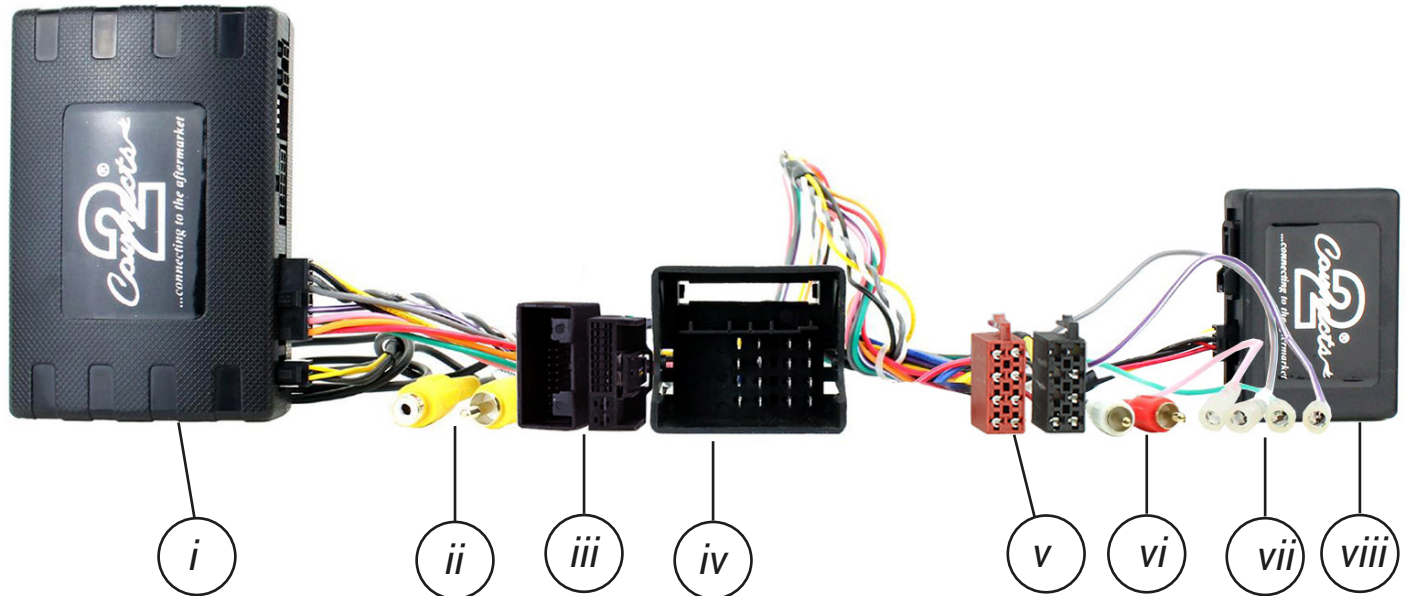

CTUAU02

Infodapter Interface for Audi Vehicles



- i. Interface Box
- ii. Video/Camera RCA (Yellow)
- iii. 20 Way M/F Heater Connectors
- iv. Quadlock Connector
- v. ISO Connector
- vi. Red/White RCA Connectors
- vii. Flying Wires
- viii. MOST Retention Interface

Designed and
Engineered
in the UK. 

APPLICATION

Note: Application data is subject to change at any time

Audi A4 (8K)	2008 - 2016
Audi A5 Coupe (8TF, 8F7, 8TA)	2008 - 2016

For MOST amplified, 3G MMI systems only

FEATURES

- Retains Steering Wheel Control Functionality
- Retains Phone Button Functionality
- Retains MOST Amplified System
- Retains Vehicle Settings and Generates Settings Menus
- Provides Input for Aftermarket Reversing Camera
- Retains Parking Sensor Audio and Generates Parking Sensor Graphics
- Provides Outputs for Reverse Gear and Mute
- Updateable via USB (contact supplier for more information)

DISCLAIMER

The information provided in this document is subject to change without notice due to manufacturer changes and/or improvements to the product/s. This instruction manual is based on documented data and research. The manufacturer of this product cannot be held responsible for any changes made to the vehicle by the manufacturer or damages that may occur through the installation of this product in accordance with the steps outlined herein.

Please be aware that whilst we retain most of the original vehicle features with our interfaces, some features may be lost. As we continue our research, this product can be updated to support even more OEM functionality.

Currently, this interface can support the following features: Auto Headlights, Leaving Home, Come Home Light Time, Daytime Running Lights, Head Lamp Conversion, Unlock Single Door, Auto Locking, Boot Lid and Tailgate, Parking Volume Front/Rear, Parking Freq Front/Rear, Window Convenience Open Front/Rear, Windscreen Wiper Service Position, Rain Sensor, Drive Select, Auto Recirc, Synchronisation

WIRING KEY

IN ISO CONNECTOR

Purple	Right Rear Speaker +	Yellow	Permanent 12V
Purple/Black	Right Rear Speaker -	Black	Ground
Green	Left Rear Speaker +	Red	Ignition 12V
Green/Black	Left Rear Speaker -	Orange	Illumination
Grey	Right Front Speaker +		
Grey/Black	Right Front Speaker -		
White	Left Front Speaker +		
White/Black	Left Front Speaker -		

ADDITIONAL CONNECTIONS

Purple/White	Reverse Gear	Yellow RCA (M)	Infodapter Display Video
Light Pink	Speed Pulse	Yellow RCA (F)	Connect Aftermarket Camera
Light Green	Park Brake	Red/White RCA	Audio Retention
Grey	Mute		

INTERFACE CONNECTIONS

- ① Reverse Camera Extension Harness Input
- ② Power Harness Input
- ③ Head Unit Connection (Patch) Lead Input
- ④ DIP Switch 1 - 'ON' for Pioneer, 'OFF' for other brand head units
 DIP Switch 2 - 'ON' for PAL reversing camera, 'OFF' for NTSC reversing camera (Default is 'OFF'/NTSC)
 DIP Switch 3 - Change from 'OFF' to 'ON' and back to reset screen settings to factory defaults.
Note: During this procedure, the screen background will change to red and no settings adjustments can be made.
 DIP Switch 4 - Not Used
- ⑤ Not used

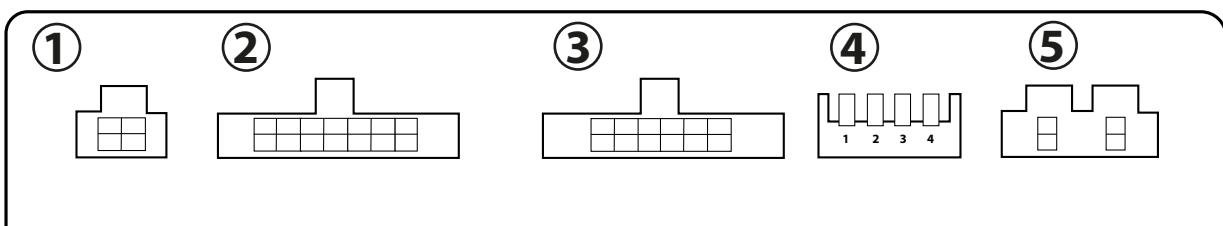

PRIOR TO INSTALLATION

Read the manual prior to installation. Technical knowledge is necessary for installation. The place of installation must be free of moisture and away from heat sources. Please ensure that the correct tools are used during the installation to avoid damage to the vehicle or product. Connects2 can not be held responsible for the installation of this product.

INSTALLATION GUIDE

See Wiring Diagram on Pg.4 for more information

Before installing the interface, the factory stereo must be removed and disconnected. To do this, please consult the vehicle owner's manual/handbook or contact a fitting professional.

A stereo connection (patch) lead is also required for the installation of this interface (supplied separately). Please ensure that you have the correct lead before proceeding. For universal patch leads, prepare the wiring loops in accordance with the instruction manual supplied with the product before installation.

1. Connect the 12 Pin connector from the stereo connection (patch) lead to the interface box
2. Connect the opposite end of the stereo connection (patch) lead to the steering wheel control input on the back of the aftermarket stereo.

NOTE: This may be a 3.5mm jack connector or a wired input depending on the brand of aftermarket stereo being fitted. Please consult the aftermarket stereo installation manual for further information on where to make the connection.

! IMPORTANT: THIS STEP MUST BE COMPLETED BEFORE CONNECTING POWER TO THE INTERFACE. FAILURE TO DO SO MAY RESULT IN A LACK OF FUNCTIONALITY AND THE NEED TO REINSTALL THE PRODUCT

3. Connect the 14 Pin connector from the supplied wiring loom to the interface box.
4. Connect 4 Pin camera extension harness to the interface box.
5. Connect the power/speaker ISO connector to the power/speaker ISO connector at the rear of the aftermarket stereo.
6. Connect the amplifier retention interface to the 8 Pin connector on the supplied wiring loom.
7. Remove the plastic dust cover from the amplifier retention interface and plug in the vehicle's fiber amplifier connection.
8. Connect flying wires from the main wiring harness to the head unit. *See 'Additional Connections' for more information.*
9. Connect the red/white RCA connectors from the harness to the rear of the aftermarket head unit.
10. Connect the male yellow RCA from the camera extension harness to the reverse camera input of the aftermarket head unit.
11. To add an aftermarket reversing camera: connect female yellow RCA from the camera extension harness to the male yellow RCA of the aftermarket camera.
12. Connect both of the 20 Way Male and Female connections to the pre-existing heater matrix connectors from the vehicle.
13. Connect the quadlock connector on the supplied harness to the quadlock connector from the vehicle.
14. Test stereo and steering wheel control functionality for correct operation before reassembling the vehicle dashboard. If steering wheel control functions are unresponsive, please uninstall the interface and wiring and reinstall carefully in accordance with the above steps.

WIRING DIAGRAM

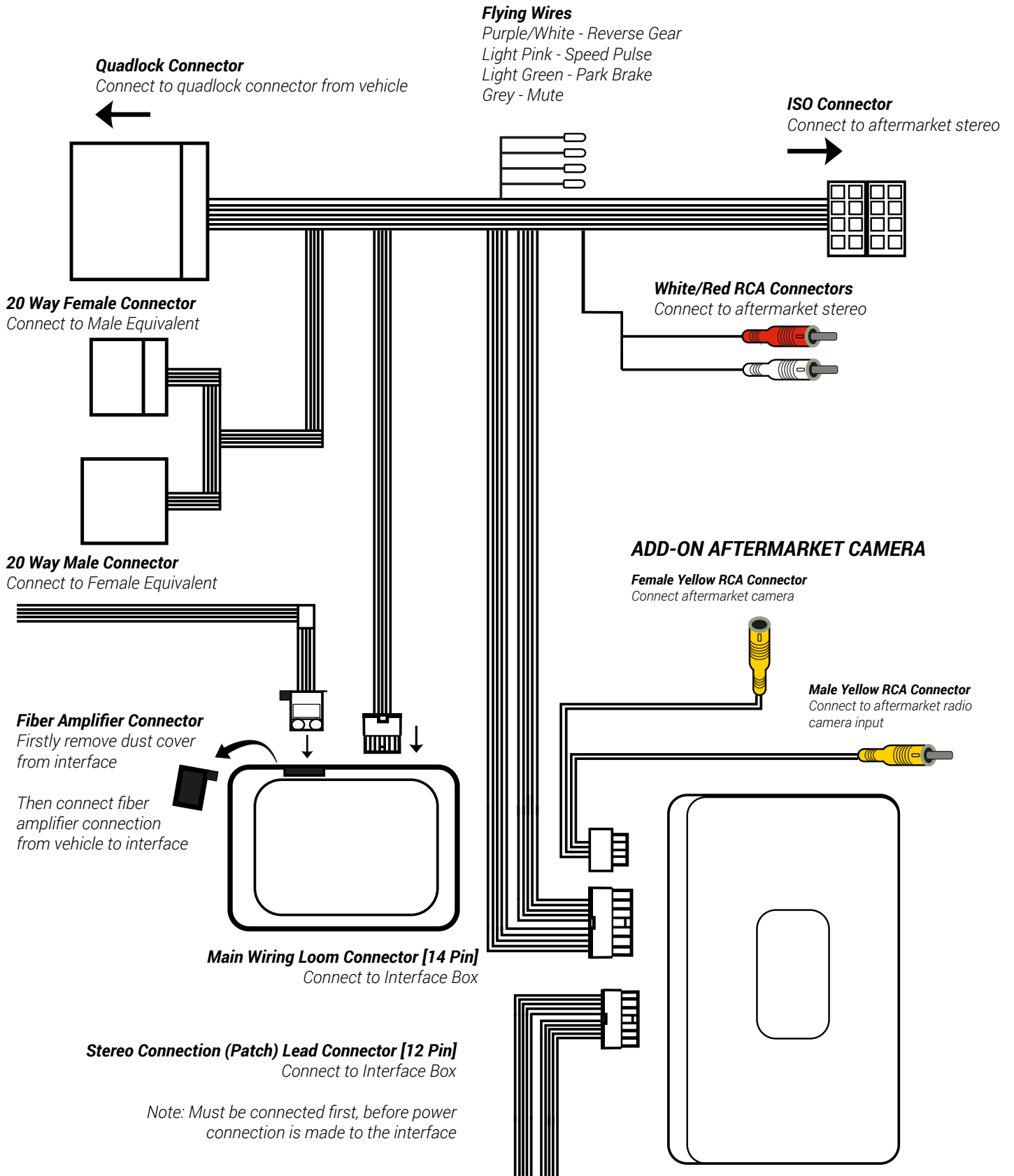

USER GUIDE

STEERING WHEEL CONTROL FUNCTIONALITY

The following diagram, though based on careful research, is an example only. Individual steering wheel control configurations may differ.

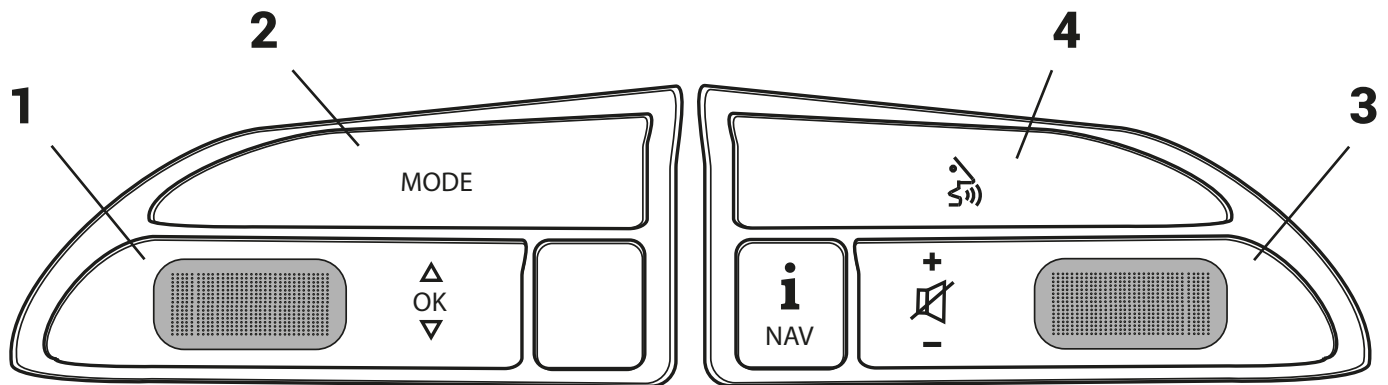

In Normal Mode

- | | | | |
|----|---|----|--|
| 1. | Track + (Scroll Up)
Track - (Scroll Down)
Source (Short Press)
Enter Infodapter Menu (Long Press) | 3. | Volume + (Scroll Up)
Volume - (Scroll Down) |
| 2. | Source (Short Press)
Enter Infodapter Menu (Long Press) | 4. | Pick Up (Short Press)
Hang Up (Long Press) |

In Infodapter Menu

- | | | | |
|----|--|----|--|
| 1. | Menu Up (Scroll Up)
Menu Down (Scroll Down)
Select Menu Item (Short Press) | 3. | Volume + (Scroll Up)
Volume - (Scroll Down) |
| 2. | Select Menu Item (Short Press) | 4. | Pick Up (Short Press)
Hang Up (Long Press) |

To exit the Infodapter Menu, select 'EXIT'

INFODAPTER MENU

Press and hold **Button 1** or **Button 2** to enter the Infodapter Configuration menu and navigate through the various options and settings below:

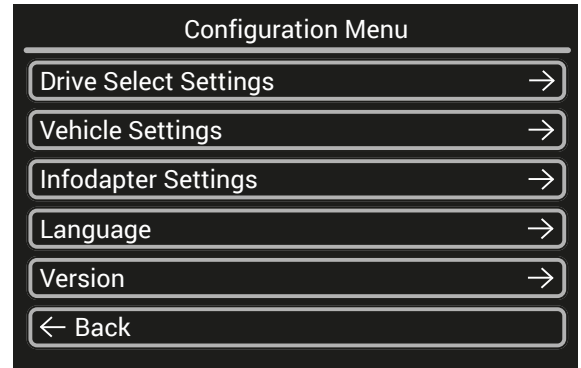

DRIVE SELECT SETTINGS

-> **Individual / Comfort / Auto / Dynamic / Off Road / Efficiency**

Select the desired drive mode from the list of options

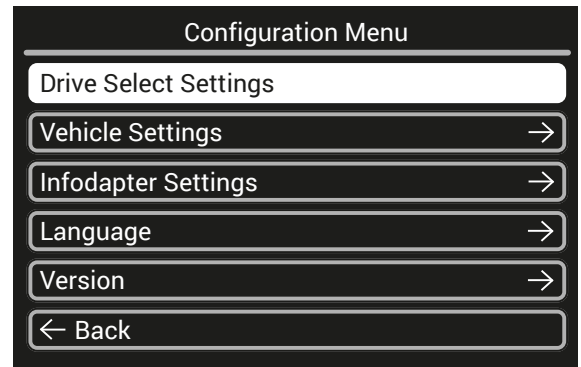

VEHICLE SETTINGS

The Infodapter interface currently retains the following vehicle settings*:

**Note: Although care has been taken to ensure the accuracy of this menu structure at the time of printing this document, sudden changes in software by the manufacturer or incompatibilities with the interface cannot be accounted for. Do not consider this list to be exhaustive.*

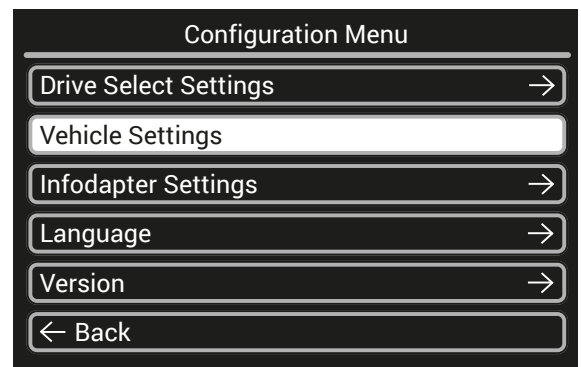

Air Con

Time/Date

- > Hours
- > Minutes
- > Years
- > Month
- > Day

Amplifier Settings

- > Volume
- > Treble
- > Bass
- > Fader

Lights

- > Come Home Light Time
- > Leaving Home Lights
- > Auto Headlights
- > Daytime Running Lights
- > Headlamp Converter

Central Locking

- > Unlock Single Door
- > Auto Locking
- > Boot Lid & Tailgate

Parking System

- > Display
- > Front Volume
- > Front Frequency
- > Rear Volume
- > Rear Frequency

Windows & Wipers

- > Convenience Open Front
- > Convenience Open Rear
- > Wiper Service Position
- > Rain Sensors

INFODAPTER SETTINGS

-> Screen Size/Position

- > Horizontal Size
- > Horizontal Position
- > Vertical Size
- > Vertical Position

-> Picture Settings

- > Brightness
- > Contrast
- > Saturation

-> Preferences

- > Camera Connected
Choose the style of camera connected to the vehicle (if applicable)
- > Park Brake Source
Set Park Brake output to activate when park brake is on (Brake), when speed is less than 3km/h (Speed) or to remain on at all times (Always On)
- > Restore Factory Settings
Select Yes to return all Infodapter settings to factory defaults

-> Installer Menu

The Installer menu will display a variety of options which can be added to or removed from the Infodapter menus.

Each option can be set to 'OFF' to remove the option from the menus, or to either 'ON' or '*AUTO' to display it

e.g. If the Language option is changed to 'OFF' in the Installer Menu, the option will disappear from the main Configuration Menu. To make the option reappear, return to the Installer Menu and toggle the feature to 'ON'

*Note: Selecting 'AUTO' will make the selected option appear in the Infodapter menus **only if the vehicle detects that the option is available**. This is only available for features that the car can detect, so will not appear against some options.

LANGUAGE

- > Select language (English/French/German/etc)

VERSION

- > View software version screen

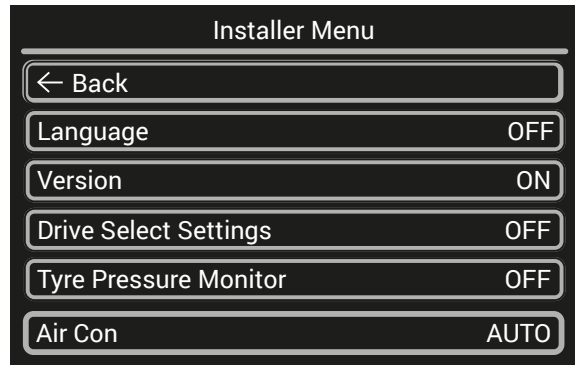
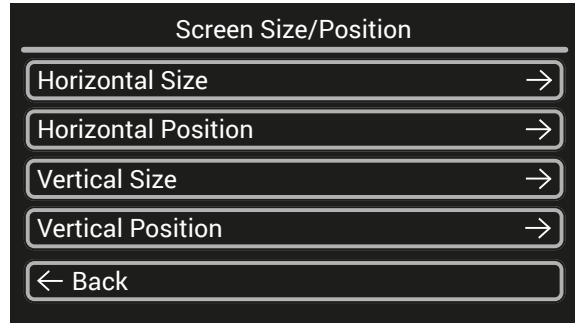
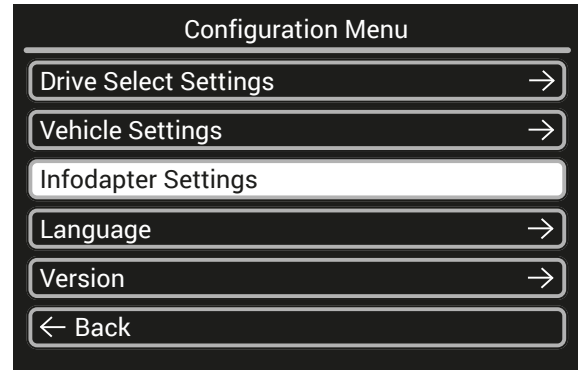

Need Help?

No problem.



support.connects2.com/tickets

Send us a ticket online 24/7

Troubleshoot with our skilled team

Get support until your issue is resolved